

Data Sheet

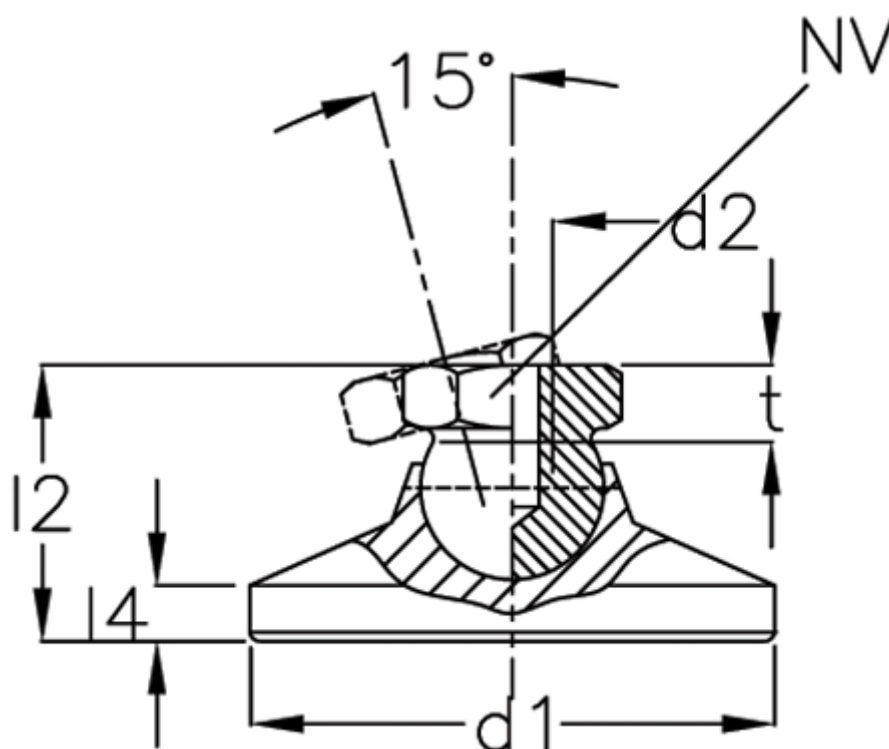

Article number: 20343150M10OS
Description: E+G levelling foot
GN 343.1-50-M10-OS

Measures



d1	= 50
d2	= 10
l2	= 28
l4	= 7
NV	= 15
Static load (kN)	= 23
t min	= 10.5